

MDRILL ZERO | CONNECTION GUIDE

PC

 **THRONMAX**

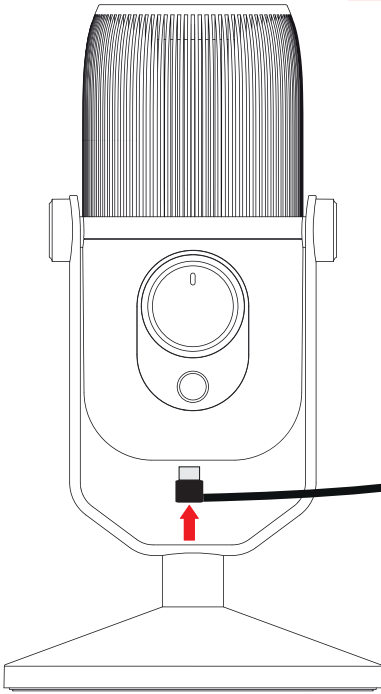

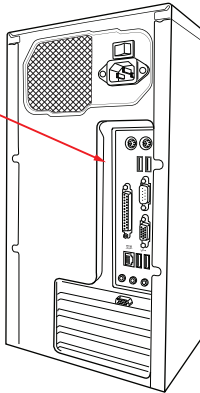
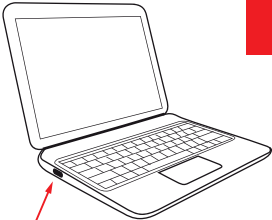
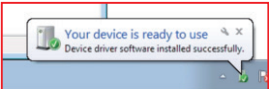

- 1. Plug Microphone to PC from USB port
Пожалуйста, подключите микрофон к USB-порту компьютера
Schließen Sie das Mikrofon über den USB-Anschluss an den PC an.
Anslut mikrofonen till PC via USB-port
请将麦克风的USB接口与电脑连接

2

2. Microphone support headphone monitoring

Порт для наушников с поддержкой нулевой задержки контроля записи

Mikrofon unterstützt Kopfhörer-Monitoring

Uttag för hörlurar

麦克风支持耳机使用

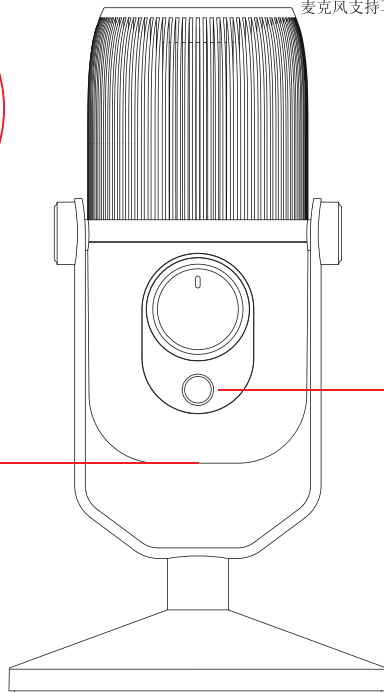
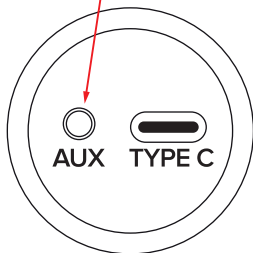

3. Headphone volume knob

Регулятор громкости наушников

Kopfhörer-Lautstärkereglер

Hörlursvolym

中间的小旋钮可以调节耳机的音量

4. Once plug microphone windows recognize automatically, If not, you can set from control panel/sound.

Микрофон автоматически распознается вашим устройством. В случае если микрофон не обнаружен, настройте его как устройство ввода через панель управления.

Sobald das Mikrofon angeschlossen ist, wird es von Windows automatisch erkannt. Wenn nicht, können Sie dies über das Bedienfeld / Sound einstellen.

Windows känner igen mikrofonen automatiskt när du ansluter den. Om inte, gå till ljudinställningarna i Kontrollpanelen

电脑可以自动识别麦克风并连接，如果不成功，可以从电脑的声音控制里面去重新设置，并选择我们麦克风设备名称 *Thronmax Zero*

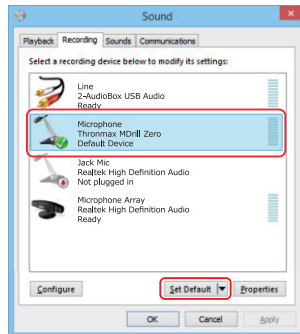
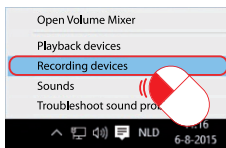
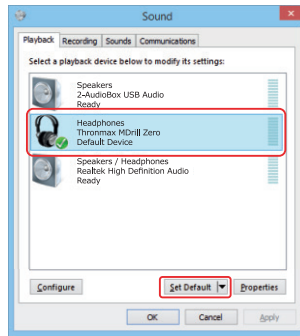
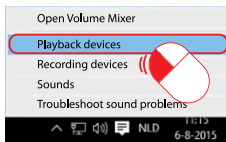

5. Set microphone sensitivity from control panel/sound.

Настройте уровень чувствительности и дополнительные параметры через панель управления в разделе «Звук» > «Свойства».

Einstellen der Mikrofonempfindlichkeit über das Bedienfeld/Sound.

Ställ in mikrofonens känslighet i Kontrollpanelen

从控制面板里面设置耳机音量和麦克风灵敏度

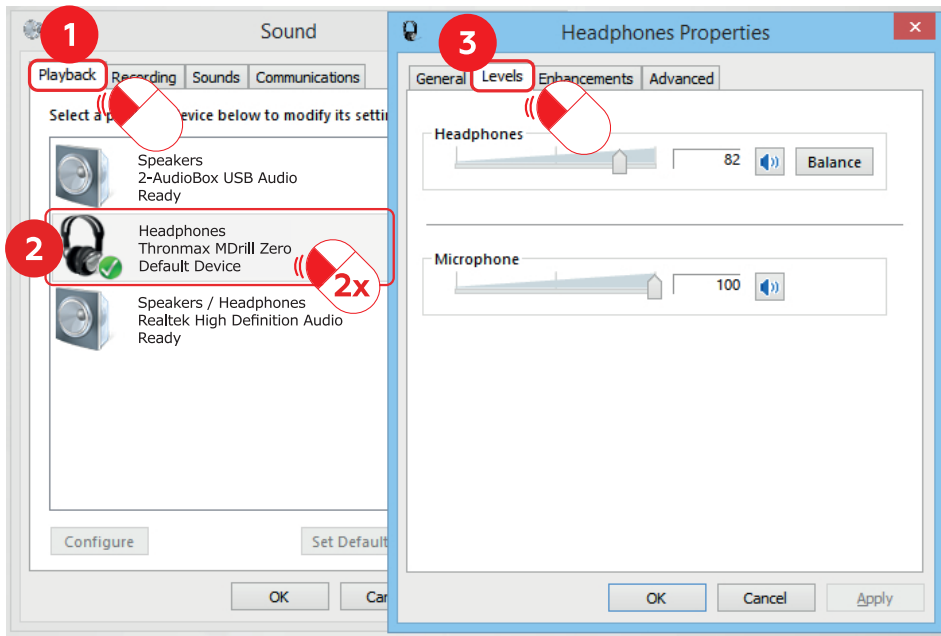

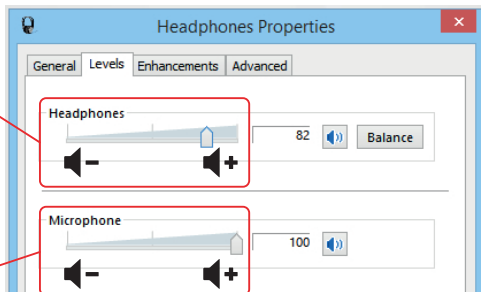
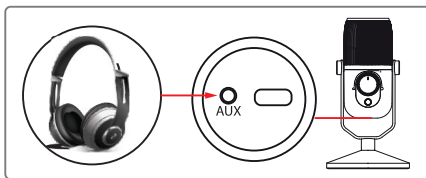

6. Please use microphone right direction.

Пожалуйста, используйте микрофон, как показано ниже.

Wählen Sie die gewünschte Richtcharakteristik aus.

Se till att använda mikrofonen från rätt håll

请根据不同的使用场景来相应地调整麦克风模式。

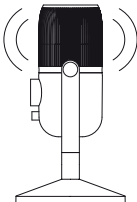
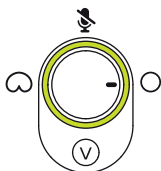
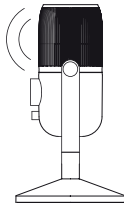
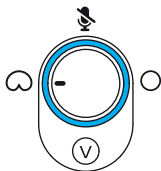
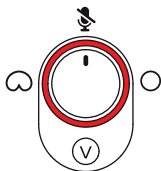

MDRILL ZERO | CONNECTION GUIDE

MAC

 **THRONMAX**



1

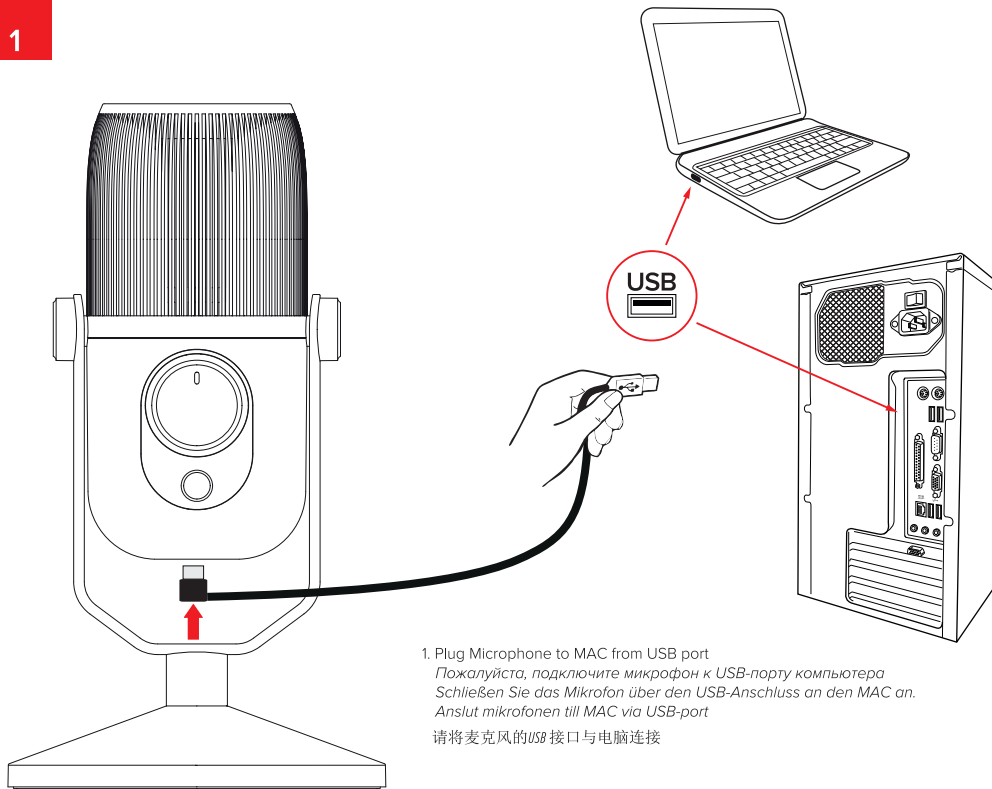

1. Plug Microphone to MAC from USB port
Пожалуйста, подключите микрофон к USB-порту компьютера
Schließen Sie das Mikrofon über den USB-Anschluss an den MAC an.
Anslut mikrofonen till MAC via USB-port
请将麦克风的USB接口与电脑连接

2. Microphone support headphone monitoring
Порт для наушников с поддержкой нулевой задержки контроля записи
Mikrofon unterstützt Kopfhörer-Monitoring
Uttag för hörlurar
麦克风支持耳机使用

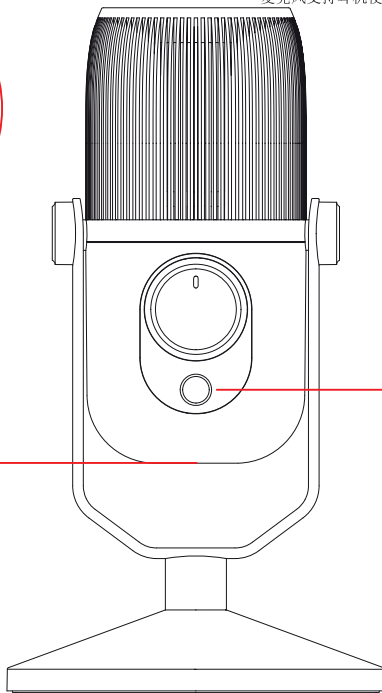
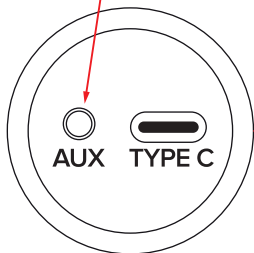

3. Headphone volume knob
Регулятор громкости наушников
Kopfhörer-Lautstärkereglер
Hörlursvolym
中间的小旋钮可以调节耳机的音量

4. Once plug microphone, the operating system recognizes automatically, If not, you can set from control panel/sound.

Микрофон автоматически распознается вашим устройством. В случае если микрофон не обнаружен, выберите его в настройках в разделе «Звук» в качестве устройства ввода

Sobald das Mikrofon angeschlossen ist, wird es von MacOS automatisch erkannt. Wenn nicht, können Sie dies über das Bedienfeld / Sound einstellen.

MacOS känner igen mikrofonen automatiskt när du ansluter den. Om inte, gå till ljudinställningarna i Kontrollpanelen

电脑可以自动识别麦克风并连接，如果不成功，可以从电脑的声音控制里面去重新设置，并选择我们麦克风设备名称Thronmax Zero

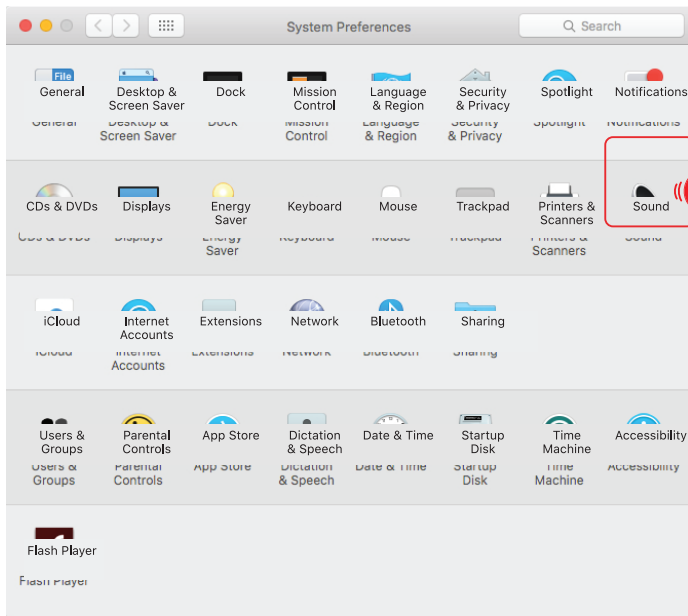

5. Set microphone sensitivity from control panel/sound.

Отрегулируйте уровень чувствительности в меню настроек ввода.

Einstellen der Mikrofonempfindlichkeit über das Bedienfeld/Sound.

Ställ in mikrofonens känslighet i Kontrollpanelen

从控制面板里面设置耳机音量和麦克风灵敏度



1

2

Output volume: Mute

Show volume in menu bar

1

2

Input volume: Mute

Show volume in menu bar

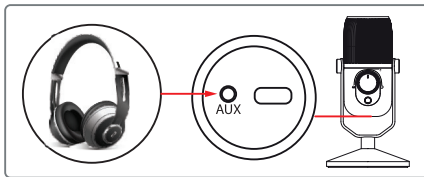

Other



QuickTime Player



TextEdit



Grapher



DVD Player



Time Machine



Font Book



Chess



Stickers



Image Capture



VoiceOver Utility



AirPort Utility



Migration Assistant



Terminal



Activity Monitor



Console



Keychain Access



System Information



Automator



Script Editor



Disk Utility



Boot Camp Assistant



Digital Color Meter



ColorSync Utility



Grab



Bluetooth File Exchange



Audio MIDI Setup



Connection Utility



XQuartz

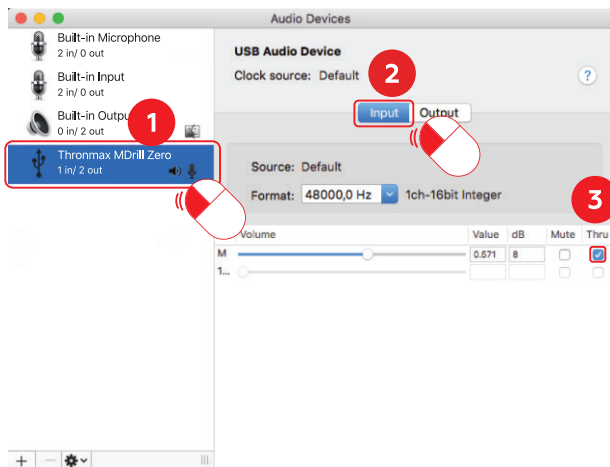
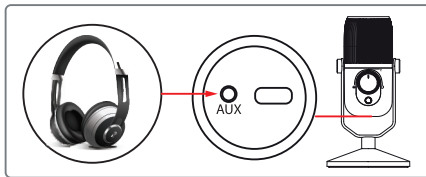

6. Please use microphone right direction.

Пожалуйста, используйте микрофон, как показано ниже.

Wählen Sie die gewünschte Richtcharakteristik aus.

Se till att använda mikrofonen från rätt håll

请根据不同的使用场景来相应地调整麦克风模式。

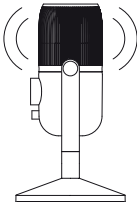
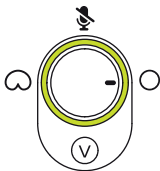
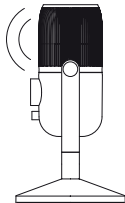
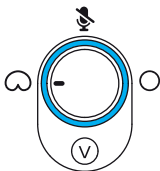
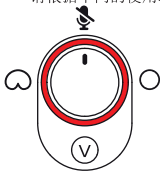



THRONMAX WARRANTY CARD

Full Name* _____ (Mr. / Ms.)

Phone number _____

Address _____

Purchase date* _____

Serial no.* _____

Model no.* _____

Purchase store _____

Retailer tel. _____

E-mail * _____

() indicates the required fields*

Disclaimer

THRONMAX reserves the final explanation of THRONMAX professional steaming microphone product, any third party applies device related information without THRONMAX's authorization is not allowed, we will take legal action. In any case, THRONMAX Ltd. is not responsible for any consequences caused by improper use of consumers.

Warranty Card

1. Warranty period:

12 months beginning on the date of purchase.

2. For the duration of the Warranty Period, THRONMAX warrants the Product against defects in materials and workmanship arising from Normal Use of the Product.

3. During the warranty period, if any of the followings occurs, certain maintenance costs will be charged:

- Product damage due to fire, flood, abnormal voltage or other natural disasters.
- The malfunction and damage caused by incorrect use, the unauthorized repairs and alteration.
- Not able to present warranty card and purchase receipt.

- The user information on warranty card is not recorded clearly or correctly.

- Product malfunction caused by the fall and improper transportation after purchase.

- Product damage caused by disassembling and repairing by user without being checked by maintenance staff from authorized store.

- The warranty card is missing the full name, purchase date, product model no., and serial no., or texts have been changed.

4. Whether or not during the warranty period, if any of the followings occurs, no maintenance provided:

- Color fading, wearing after using under proper use is not covered by warranty terms.

- If product model no. and serial no. filled in warranty card is not consistent with official product model no. and serial no, it is not covered by warranty terms.

5. Notice:

- This warranty card cannot be reissued in any case, please keep it properly and present it when repairing.

- If you have any question regarding after-sale service, please contact us or the retailer.

Address: Thronmax

4 Floor No.1 Building China&Israel High-Tech park Huanhu road
NO.7 Songshan Lake Dongguang, Guangdong,523808 China

